



QuickStart Guide & Instruction Manual (RED PCB)

TIP:

In this guide, RX refers to the WEL-200 Receiver, and TX refers to the WEL-200 Transmitter.

Page 1-6: QuickStart Guide

Page 7-11: Instruction Manual

Mounting the RX and TX

ATTENTION: Failure to mount the RX properly may result in poor battery life in TX units.

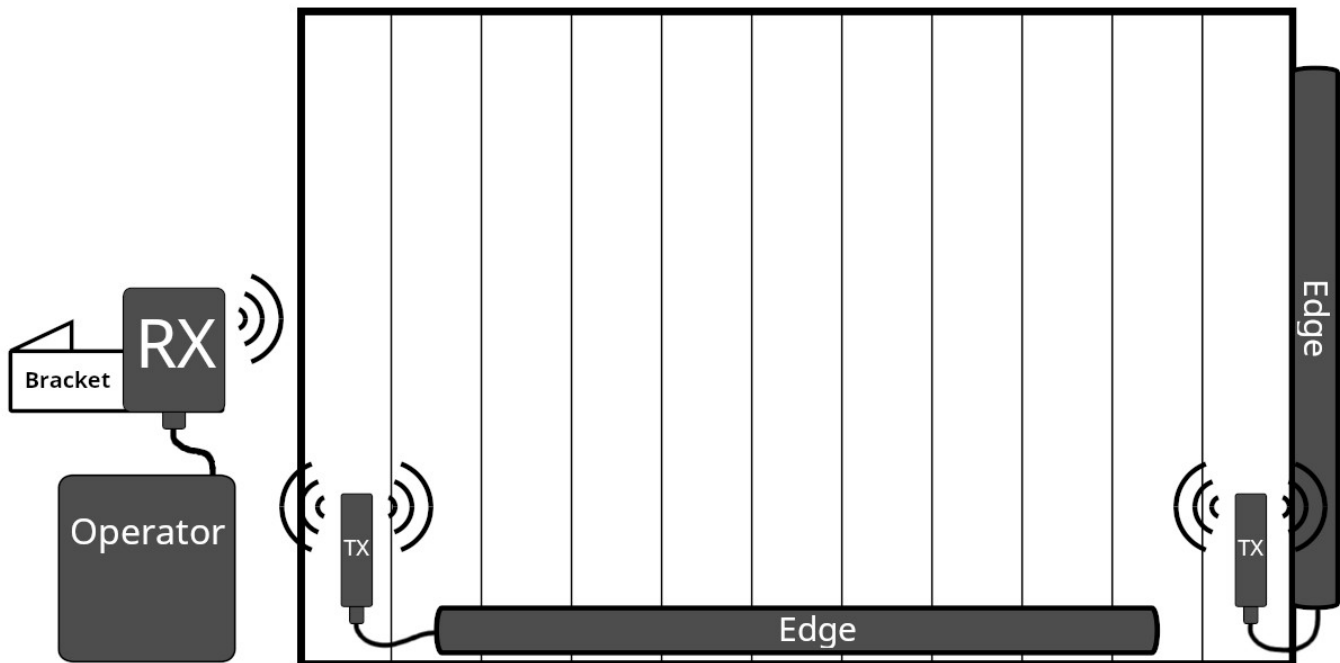

*Mount TX at least 6" or 75mm off the ground

Line of Sight:

When mounting a WEL-200 system, Line of Sight must exist between the RX and each TX to ensure a good wireless connection.

Line of Sight is illustrated below:

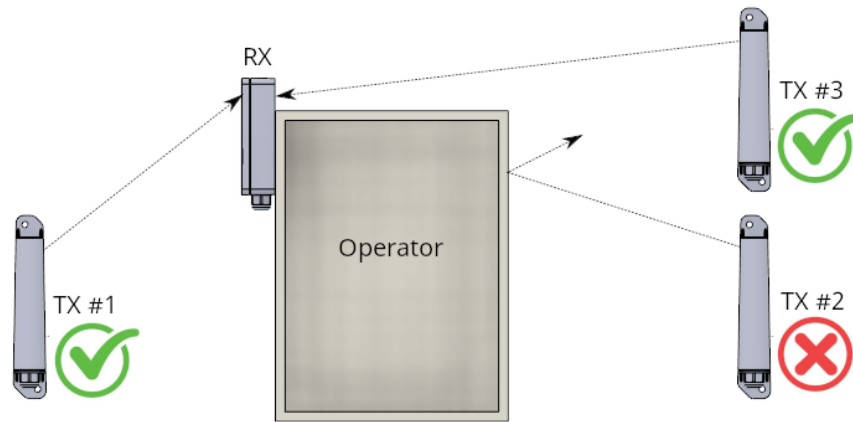

In the diagram, TX #1 and TX #3 have LINE OF SIGHT to the RX. TX #2 **does not** have LINE OF SIGHT to the RX because the operator will block the wireless signal. TX #2 may suffer from a poor connection and poor battery life.

Mounting the RX:

Mount the RX to the **exterior** of the operator housing using #8 machine screws (the mounting holes can be accessed by removing the front cover). The RX must overhang the operator housing by about 1" (25mm) so that the antenna is not blocked. The antenna zone is illustrated below.

BEST PRACTICE: Install the RX using an L-bracket. Take care to **NOT** block the antenna zone.

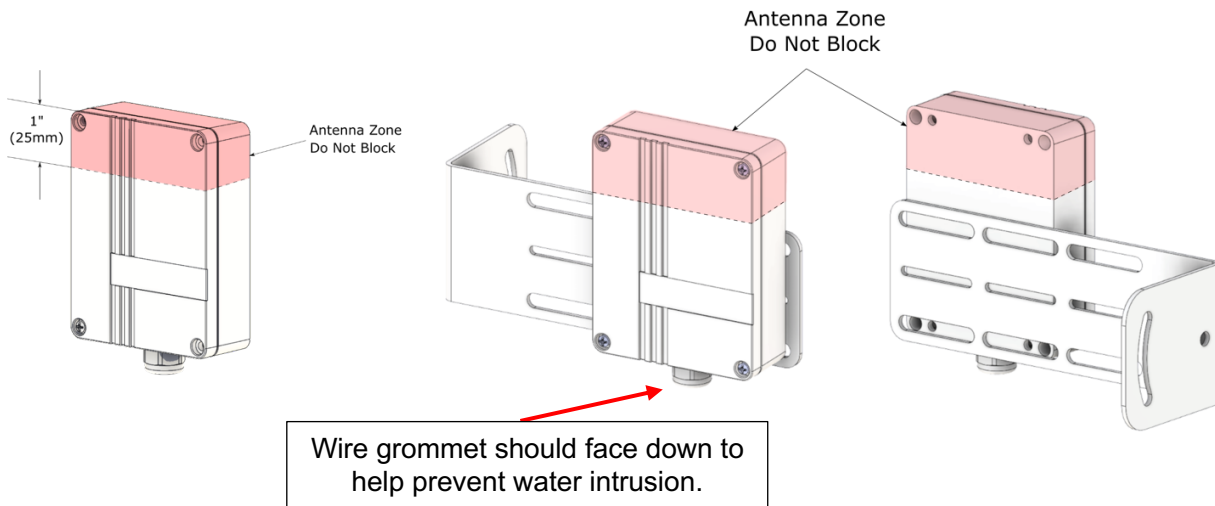

Never install the RX inside an operator box, especially a metal one:

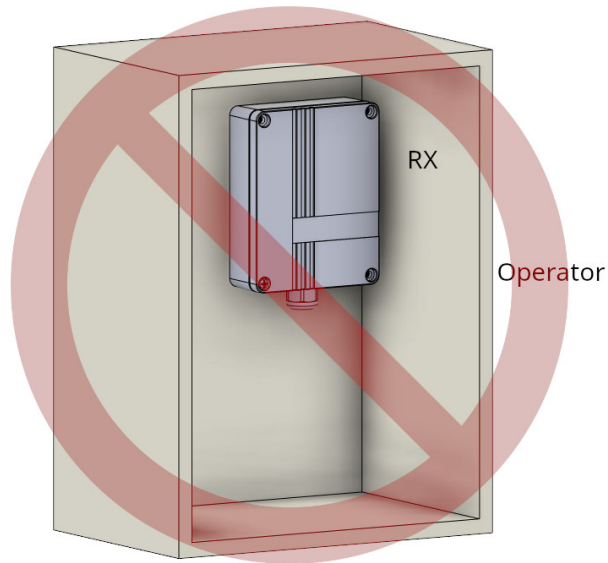

Examples of good and bad installations are shown below:

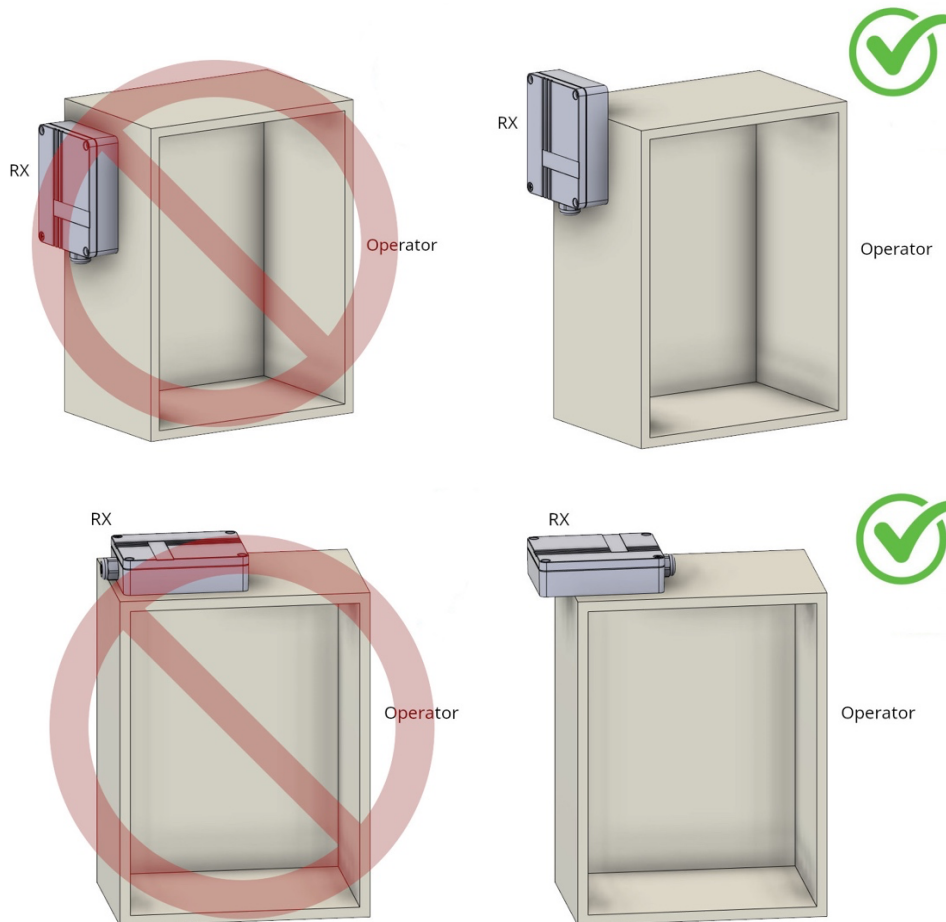

Even though there are 4 mounting holes on the RX, it's OK to just use 2 holes so that the RX will overhang the operator box as shown above. When mounting the RX, make sure the cable grip is facing down or to the side, never up – this will prevent water from getting in.

Mounting the TX:

Mount each TX near its sensing edge: First, wire the sensing edge into the TX's terminal blocks. There is no polarity on this wiring. Next, use two #8 machine screws to secure the TX to the gate. Recommended locations are shown below for the front and side of a gate:

TX Recommended Mounting

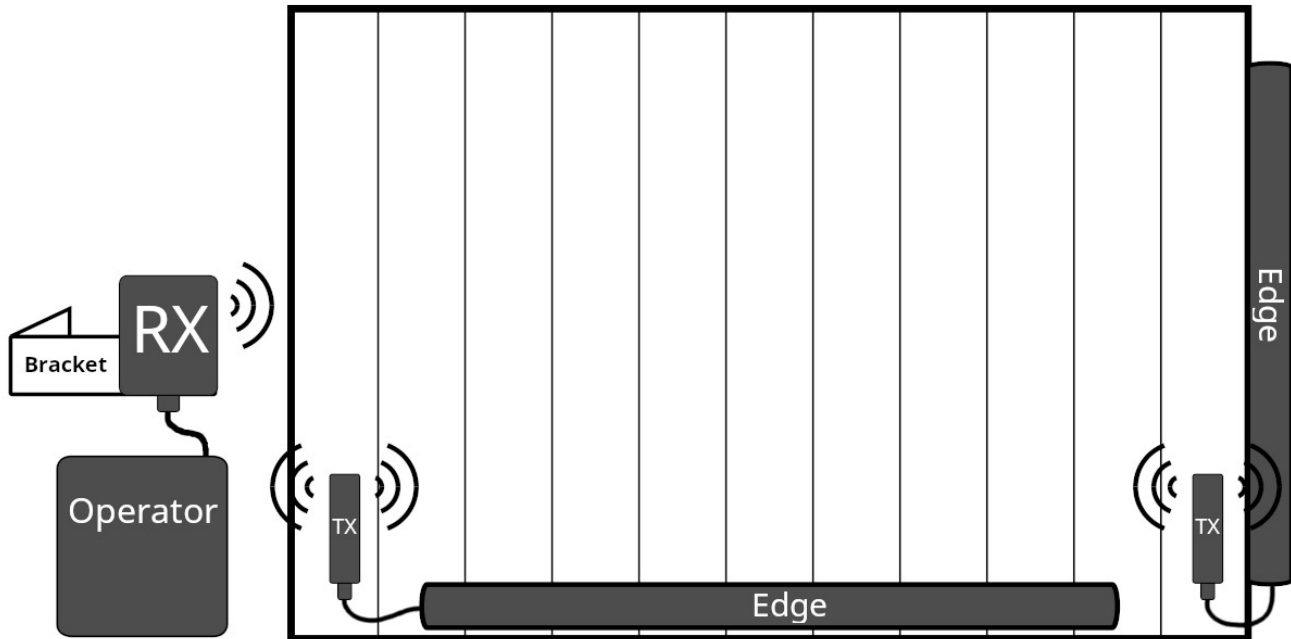

*Mount TX at least 6" or 75mm off the ground

BEST PRACTICE: When mounting TX and RX unit, **mount with wire grommet facing down** to prevent water intrusion.

Receiver Wiring

1. All wiring to WEL-200 devices must pass through the sealing cable grip to keep the devices waterproof.

2. Wire power from the operator to RX terminals **11 & 12**.

The acceptable input voltage range is **12-24VDC/AC**.

3. On the RX board, set **DIP switches 1 through 4** to "**RELAY 1**" position. This will make all four transmitter channels output through the **PULSE 1** and **RELAY 1** terminals. If more than one relay is required for the install (Open & Close Edges) refer to the WEL-200 operating instructions.

WEL-200 Receiver Screw Terminal Block

Reference the image below for terminal numbers in step 4 - 7

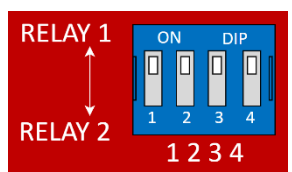
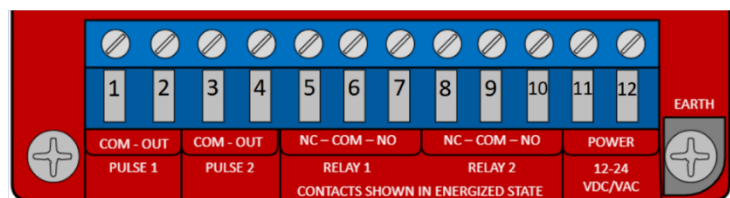

4. Determine the monitoring method the gate operator requires. The WEL-200 supports 10K and normally closed monitoring, as well as 4-wire 300/0Hz pulsed outputs.

5. For **10K monitoring**, wire operator common to terminal **6**, and the operator safety input to terminal **7**. Place the 10K enable jumper into the bottom or **ON** position (see top photo on the right).

6. For **NC monitoring**, wire operator common to terminal **6**, and the operator safety input to terminal **5**. Place the 10K enable jumper into the top or **OFF** position (see bottom photo on the right).

7. For **4-wire 300Hz/0Hz Pulsed monitoring**, wire the operator common to terminal **1** and the operator safety input to terminal **2**.

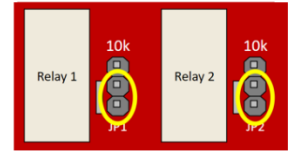

10K position

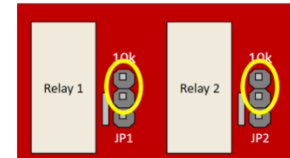

NC position

Getting the WEL-200 RX & TX Ready for Pairing (Factory Reset)

1. Insert two AA lithium batteries into the TX devices that will be paired. Apply power to the RX board.

TIP: Energizer AA Ultimate Lithium batteries must be used to obtain 2-years of battery life

2. After ~15 seconds of power being applied, the RX board should have its **SYSTEM STATUS LED** (below DIP switch) and the four **CHANNEL LEDs** (near push-buttons) blinking at the exact same rate, these are the five green LEDs on the board.

If any of the **CHANNEL LEDs** have a different blink-rate, press and hold both **CH1 and CH4 push-buttons** simultaneously until the **STATUS LED** starts blinking at a quicker rate.

This performs a factory reset and clears all previous connections. Give ~15 seconds for the device to return to a normal operating state. (Five green LEDs flashing in sync)

3. After inserting the batteries into the TX, observe the blink pattern on the **TX Status LED** (located near push-button and edge terminal). The LED should be blinking **twice quickly** every four seconds.

If you see any other blink pattern, press and hold the **TX Button** until the blink pattern described above is displaying. This removes any previous connection that may have been programmed to this transmitter.

Pairing the RX & TX

1. On the RX board, press and hold **CH1 Button** until you see the **SYSTEM STATUS LED** blink at a faster rate. This puts the RX into **PAIR MODE** for CH1. You will have two minutes to complete the pair on the TX before the pairing session times out.

2. On the TX that is to be paired, press and hold its push-button. The TX LED will begin blinking rapidly while the TX is trying to pair. Hold down the push-button until the TX's LED flashes once every four seconds, indicating a successful pair.

If the pair is failing, the TX LED will continue to blink fast while the TX Button is being held.

3. Observe the **CH1 LED** on the RX board to see the connected TX's status.
One of the three states below should be seen.
 - If an edge sensor is wired to the paired TX and is not shorted, then the **RX CH1 LED** should be **OFF**.
 - If an edge sensor is not wired, the **RX CH1 LED** will **flash twice quickly every second**.
 - If an edge sensor is wired but it is shorted (compressed), then the **RX CH1 LED** will be **ON** until the short is removed.
4. Start an open cycle and ensure shorting (compressing) the edge sensor stops the gate/door.
5. Repeat steps 1 through 4 using CH2, CH3, or CH4 for additional transmitters.



Instruction Manual

(For red circuit boards)

The WEL-200 is a complete wireless solution for interfacing sensing edges to gate and door operators, while ensuring compliance with UL325 monitoring standards. **The WEL-200 Transmitter (per page 4, step 6) requires the edge (sold separately) to have a built-in resistor with a value between 4K - 12K ohms. Non-resistive edges DO NOT work with this system.** Each receiver can connect with up to four transmitters with separate relay and pulse outputs for open and close edge functionality. Each transmitter can run for up to two years on two AA lithium batteries. With enhanced diagnostic features, installation and maintenance for the WEL-200 is easy and reliable. Feedback is provided for all fault modes, including edge open, short conditions, low battery and failed transmitters.

Specifications

	Receiver (WEL-200R)	Transmitter (WEL-200T)
Operating Range	200 ft (line of sight)	
Operating Frequency	915 MHz (25 possible channels)	
Response Time	100 ms	
Operating Temperature	-40° to 140°F (-40 to 60°C)	
Power	12-24 VDC/AC	2 AA lithium batteries ~ 2 year life
Current Draw	1 Relay - 42mA, 2 Relay - 70mA	N/A
Surge Protection	Thermal fuse, MOV	Thermal fuse
Outputs	300 Hz pulsed, or relay with selectable 10K ohm resistor across normally open contact	N/A
Edge Resistance Range	-	4K - 12K Ohms
Dimensions	5.5" (140 mm) x 1.3" (34 mm) x 3.5" (90 mm)	7" (180 mm) x 1.3" (32 mm) x 2.6" (67 mm)
Connections	12 terminals	2 terminals

Ordering Information

- WEL-200K Wireless edge link kit, includes WEL-200R, WEL-200T, 2 cable grip inserts and 2 AA lithium batteries
- WEL-200R Wireless edge link receiver
- WEL-200T Wireless edge link transmitter

Receiver Connections

1. Channel assignment buttons

2. Channel LEDs

- Off when a paired transmitter has a good edge sensor
- On when a paired transmitter has a shorted edge sensor
- Flashes in sync with system LED when no transmitter is paired to the channel
- Flashes 2x faster than the system LED when a paired transmitter is no longer communicating
- Flashes twice quickly with one second off when a connected transmitter has an open edge sensor.

3. Radio

4. DIP switch

- Assigns each channel to Relay 1 or Relay 2

5. Power LED

6. System Status LED

- Slow flash during normal operation
- Fast flash during pair or factory reset

7. Relay 1 10K Jumper

8. Relay 2 10K Jumper

9. Earth ground

10. Terminal block

WEL-200 Receiver

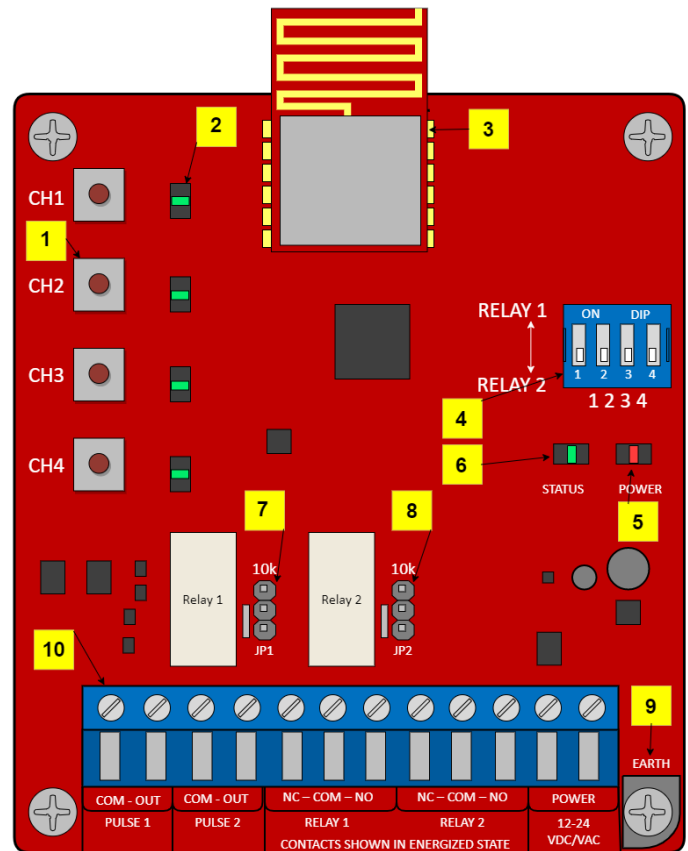

Terminal	Description
PULSE 1 COM	Pulse common connection for channels assigned to Relay 1 on DIP switch
PULSE 1 OUT	Pulse output for channels assigned to Relay 1 (300/0 Hz)
PULSE 2 COM	Pulse common connection for channels assigned to Relay 2 on DIP switch
PULSE 2 OUT	Pulse output for channels assigned to Relay 2 (300/0 Hz)
RELAY 1 NC	Normally closed relay connection for channel assigned to Relay 1 on DIP switch
RELAY 1 COM	Common relay connection for channels assigned to Relay 1
RELAY 1 NO	Normally open relay connection for channels assigned to Relay 1
RELAY 2 NC	Normally closed relay connection for channel assigned to Relay 2 on DIP switch
RELAY 2 COM	Common relay connection for channels assigned to Relay 2
RELAY 2 NO	Normally open relay connection for channels assigned to Relay 2
POWER	12-24 VDC/AC power input (non-polarized)
EARTH	Earth ground connection (not required)

Installation

Connecting the Receiver

1. Mount the receiver to the exterior of the operator using four #8 machine screws, washers, lock washers and nuts. Open the cover to expose the mounting holes. Place the receiver in direct line of sight with all edge transmitters. Mount the receiver with the sealing nut facing down to prevent water from entering the housing.



TIP: Extend the top of the receiver approximately 1" above the top edge of the operator housing, or on the side that is in line of sight of all transmitters.

2. Pass the operator wires through the sealing nut, cable grip, and body into the receiver housing.

- TIP:**
- Cables for the original cable grip insert must be 0.181-0.321" (4.6-7.9 mm) in diameter to maintain a proper watertight seal.
 - For smaller cables, replace the original cable grip insert with a white insert by removing it from inside the body.
 - To maintain a watertight seal, 1.) only use round cables 2.) mount the receiver with the sealing nut facing down

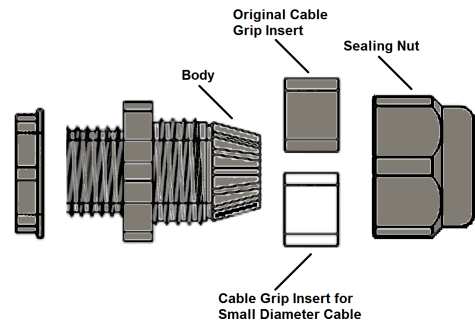

3. Connect the operator wires to the terminal block, per one of the monitoring methods below and according to the instructions provided by the operator manufacturer. **Connect power wires last.**



Pulse Monitoring

- For channels assigned to Relay 1, connect the operator common to terminal 1 and operator input to terminal 2.
- For channels assigned to Relay 2, connect the operator common to terminal 3 and operator input to terminal 4.

10K or Normally Closed Monitoring

- For channels assigned to Relay 1, connect the operator common to terminal 6, and the operator input to terminal 5 or 7.
- For channels assigned Relay 2, connect the operator common to terminal 9, and the operator input to terminal 8 or 10.
- For **10K** resistive monitoring, place the jumper on the receiver in the 10K position (bottom two pins) as shown. This places a 10K resistance across the NO relay contacts.
- For **NC**, move the jumper on the receiver to the top two pins.

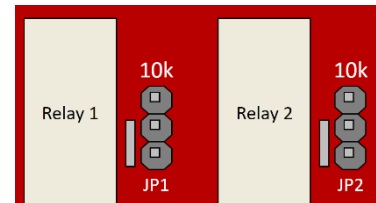

10K position

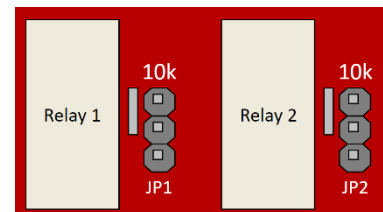

NC position

4. On the DIP switch, indicate which channels will output through Relay 1 and Relay 2 terminals. The DIP switch in the image shows all four channels outputting through Relay 2 terminals.

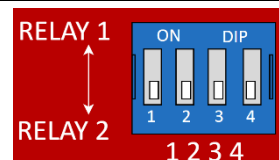

Connecting the Transmitter

5. Mount the transmitter near the edge sensor using two #8 machine screws, washers, lock washer and nuts. Pass the edge sensor wires through the sealing nut as in step 2. Mount the transmitter with the sealing nut facing down to prevent water from entering the housing.

6. Connect the resistor equipped edge sensor wires to the transmitter terminal block (#3 on image). Insert batteries. The LED (#2 on image) will quickly flash 2x every two seconds.

TIP:

- **Never connect more than one edge sensor to a single transmitter.**
- **The edge sensor must have a resistance between 4K - 12K ohms.**
- **A channel LED flashing three times per second indicates that the batteries are low (less than 2.7 V) and need to be replaced.**

7. After powering the receiver, the system status LED will flash rapidly while it is finding a clean operating frequency (this can last several seconds). Once completed, the system status LED will flash on/off every 2 seconds. Initialization is now complete.

TIP:

To perform a factory reset of the receiver, press 1 and 4 channel assignment buttons simultaneously until the status LED flashes quickly. This will clear all connected channels and reset the system.

8. To enter channel assignment mode, on the receiver, hold down the desired channel assignment button until the systems status LED begins flashing rapidly, then release the button.

To exit channel assignment mode, wait 120 seconds or cycle power to the receiver.

9. On the transmitter, press and hold down the connection button (#4 on image above) for 1 - 2 seconds until its LED stops flashing rapidly. Upon successful connection, the LED flashes once every four seconds. If the transmitter fails to connect, it will return to its initial state, with the LED flashing twice fast every two seconds. If this occurs, repeat this step. If the transmitter continues to fail to connect, proceed to the troubleshooting section.

TIP:

To remove a connection from the transmitter, hold down the connection button. The LED will turn on solid for several seconds, and then flash twice every two seconds when disconnected.

10. Test the connection. Without activating the edge sensor, observe the channel LEDs on the receiver. They should be off for any channel connected to a transmitter. Activate the edge sensor being tested. On the receiver, the channel LED for the tested edge's channel should turn on. On the transmitter, the LED should flash twice every second while the edge sensor is activated. If the channel does not exhibit this behavior, double check the edge sensor wiring, termination, and transmitter batteries.

11. Repeat steps 5 through 10 for each additional transmitter. Never connect more than one edge sensor to a single transmitter.

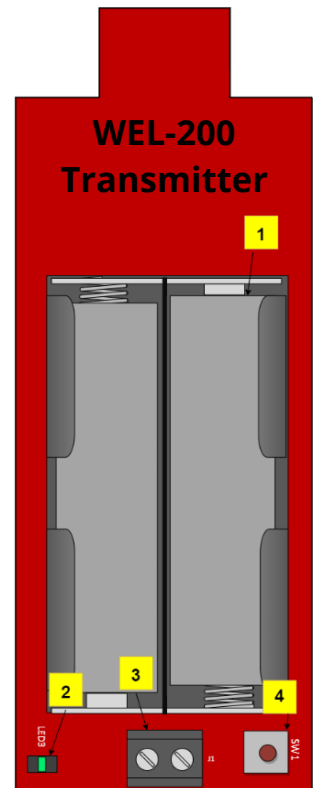

WEL-200 Compatibility (Red Board and Green Boards)

1. New WEL-200 systems (Red Boards) will not be compatible with older receivers and transmitters (Green Boards). This is because of an upgrade to the communication protocol as well as other advancements in the system's ability to find clean RF channels.

2. Using the color of the boards is the best way to determine compatibility.

-Transmitters with a **GREEN PCB** must be used with a receiver that also has a **GREEN PCB**.

-Transmitters with a **RED PCB** must be used with a receiver that also has a **RED PCB**.

Troubleshooting

Symptom	Possible cause	Solution
Receiver channel LED is on, regardless of edge sensor state	Edge sensor's resistance is too low Edge wires are shorted	<ol style="list-style-type: none"> 1. Disconnect edge sensor from transmitter. 2. Connect a digital multimeter to the edge leads and set to read ohms. The meter should read between 4K and 12K. 3. If the meter reads outside of this range the edge sensor is defective. Replace the edge sensor.
Receiver channel LED flashes 2x then pauses every second	Edge sensor resistance above 12K Improper connection to edge sensor Damaged wires	<ol style="list-style-type: none"> 1. Disconnect edge sensor from transmitter. 2. Connect a digital multimeter to the edge leads and set to read ohms. The meter should read between 4K and 12K. If the meter reads outside this range the edge sensor is defective. Replace edge sensor. 3. Press on the edge sensor and confirm resistance drops to zero.
Receiver channel LED flashes once per second	Transmitter not connected to receiver	Repeat step 9 in transmitter installation
Receiver channel LED flashes 0.5 seconds on, 0.5 seconds off	Poor signal Strength Completely dead batteries	Ensure Receiver and Transmitter have line of sight throughout gate open/close operation. If new AA lithium batteries are installed in transmitter and the transmitter LED does not light, then replace transmitter.
Receiver channel LED flashes 3x per second or transmitter LED flashes 6x quickly.	Transmitter batteries are low (less than 2.7V)	Replace batteries with two AA lithium batteries 1.5V

Warranty

EMX Industries, Inc. products have a warranty against defects in materials and workmanship for a period of two years from date of sale to our customer.